

**Virginia
Department
of
Transportation
Work Zone
Pedestrian
and
Bicycle
Guidance**



May 1, 2016

Table of Contents

	Page
Preface	ii
1. Introduction	1
ADA Requirements.....	1
Special Pedestrian Populations.....	2
2. Work Zones and Pedestrian Routes	
Typical ADA Pedestrian Devices.....	3
Detectable Edge Devices.....	4
Temporary Curb Ramps.....	5
3. Selecting Appropriate Temporary Pedestrian Access for Work Zones	
Definition of Terms.....	6
ADA/Pedestrian Application Charts.....	7, 8, 9
4. ADA Compliant Work Zones	
Sidewalk and Crosswalk Applications	
Mid-Block Diversion.....	12
By-Pass at Intersection.....	14
Mid-block Crossings.....	16
5. Bicycle/Shared-Use Paths	
Bicycle Guidance.....	19
Work Zone Applications	
Bicycle Lane Closure.....	21
Bicycle Lane Closure with Detour.....	22
Shared-Use Path Closure with Diversion.....	23
Shared-Use Path Closure with Detour.....	24
Shoulder Closure with a Bicycle Diversion Path.....	25
Path Closure with a Diversion Path.....	26
6. ADA/Pedestrian/Bicycle Accessibility Checklists, Resources	
ADA/Pedestrian Checklist.....	27
Bicycle Checklist.....	29
Resources.....	31

Preface

The purpose of this guidance is to present basic guidelines for work zone traffic control for pedestrians and bicyclists. It is a supplement to the current edition of the 2011 Virginia Work Area Protection Manual. These recommendations and examples apply to temporary traffic control zones, as found in construction, maintenance, permit and utility work areas. This information is intended to illustrate the principles of proper work zone traffic control for pedestrians and bicyclists, but is **not a standard**. The Virginia Work Area Protection Manual contains the standards for temporary traffic control zones for roadways in Virginia and can be accessed at VirginiaDOT.org, Business Center.

Introduction

The needs of pedestrians, including persons with disabilities, and bicyclists on all roads open to public travel must be considered in the design of any transportation facility. [The Code of Virginia, Section 15.2-2021](#), specifies streets that incorporate accessible routes for pedestrian use be accessible for use by persons with mobility impairments. The consideration of pedestrians and bicyclists is very important at a work area. Work areas by their nature are inherently confusing due to changing conditions. Work zones affecting any pedestrian facility shall maintain existing accessible routes.

This guidance provides information to aid in developing Temporary Traffic Control (TTC) Plans for pedestrians, bicyclists, and persons with disabilities. This information will assist Designers and Engineers in identifying pedestrian and bicycling issues and providing approaches for safe and effective movement through a work zone. The information contained in this pamphlet is intended to illustrate treatments and devices consistent with current practice but is not a standard. The Americans with Disabilities Act (ADA), the US Access Board's Proposed Accessibility Guidelines for Pedestrian Facilities in the Public Right-of-Way (PROWAG), the Manual on Uniform Traffic Control Devices (MUTCD), the Virginia Supplement to the MUTCD, and the Virginia Work Area Protection Manual contain specific requirements and standards for the safe and efficient movement of pedestrians and bicyclists in work zones.

ADA Requirements

Per the Americans with Disabilities Act of 1990 (ADA), Title II, Paragraph 35.130, the needs and control of all road users (motorists, bicyclists and pedestrians) through a temporary traffic control zone shall be an essential part of any roadway construction, utility work, permit and maintenance operations. The Americans with Disabilities Act guidance applies elements for pedestrian circulation in temporary facilities within the right-of-way. Pedestrian circulation and pedestrian circulation routes must be accessible to and usable by pedestrians with disabilities. Pedestrian routes may include: sidewalks, overpasses and underpasses; street crossings and refuge islands with ramps and detectable warning surfaces; pedestrian signs, including for visible characters and alternative audible sign systems; pedestrian signals, including accessible pedestrian signals and push-buttons, and pedestrian activated signals at multi-lane crossings.

Alterations to the street/roadway should not decrease the accessibility of the existing (pre work zone) pedestrian route. Alternate pedestrian access routes must be provided when a pedestrian route is temporarily closed by construction, utility work, permitted or maintenance operations. The alternate pedestrian access route must comply with the Virginia Work Area Protection Manual and the MUTCD. The standards in both manuals require any alternate pedestrian route, at a minimum, meet the accessible and detectable features of the existing closed pedestrian route. The preferred means to warn pedestrians who are blind or have low vision about sidewalk closures is an audible warning device using proximity-actuated audible signs, as recommended by the US Access Board's Proposed Accessibility Guidelines for Pedestrian Facilities in the Public Right-of-Way (PROWAG).

ADA Requirements (Con't.)

Where existing physical constraints make it impractical to comply with the above ADA requirements, compliance is required to the maximum extent practicable. All physical constraints shall be documented and retained in the project's file. Existing physical constraints include, but are not limited to, underlying terrain, limited right-of-way availability, underground structures, adjacent facilities, intersection geometry, maintaining positive drainage, or the presence of notable natural or historic features.

Special Pedestrian Populations

Special pedestrian populations include children, senior citizens and the physically disabled. Each of these populations has a unique set of characteristics that limit their ability to travel along and across streets and roadways. Children typically do not have the cognitive abilities to understand how to share the roadway with vehicles. Senior citizens are not as mobile as younger adults and may have limited hearing and vision. Individuals with physical disabilities include people with visual impairments, people with hearing impairments, and people who need to use mobility devices.

Work Zones and Pedestrian Routes

Typical ADA Pedestrian Devices

Typical ADA pedestrian devices can be separated into two groups:

- Detectable systems such as longitudinal channelizers, railings, barricades and surface warnings;
- Curb ramps.

This section will provide general information and illustrations of detectable devices and curb ramps with the exception of detectable warning surfaces. Detectable warning surfaces are covered by Federal and state regulations per the Americans with Disabilities Act of 1990, 2010 ADA Standards for Accessible Design (<http://www.access-board.gov/guidelines-and-standards/buildings-and-sites/about-the-ada-standards/ada-standards>), US Access Board's Proposed Accessibility Guidelines for Pedestrian Facilities in the Public Right-of-Way (PROWAG), the Manual on Uniform Traffic Control Devices (MUTCD), Code of Virginia and the current Road and Bridge Standards. A listing of manufacturers of these devices may be accessed at VDOT's web site: <http://www.virginiadot.org/business/trafficeng-WZS.asp>. Products are listed on the web sites because of their potential usefulness to individuals and not because they have been verified to meet any requirements or standard. Additional suppliers can be found on the Internet and through various industry associations such as the American Traffic Safety Services Association at <http://www.atssa.com/>.

It is important to note that any device placed within the clear zone of the street or roadway shall meet crashworthiness requirements appropriate for the device's application.

Additional information and requirements on ADA pedestrian devices can be accessed at <http://www.access-board.gov/guidelines-and-standards/buildings-and-sites/about-the-ada-standards>.

Detectable Edge Devices

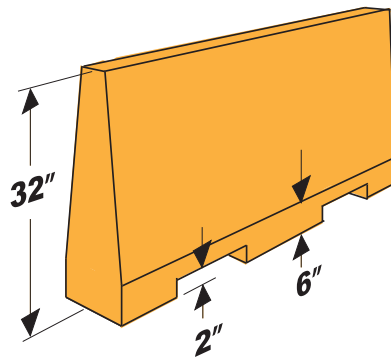

Longitudinal
Channelizer

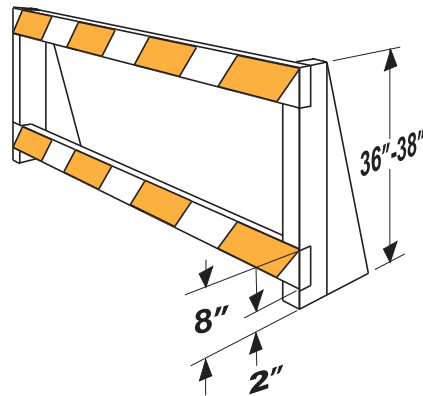

Pedestrian
Barricade

1. To prevent any tripping hazard to pedestrians, ballast shall be located behind or internal to the device.
2. Detectable edges for long canes shall be continuous, a minimum width of 6 inches, and be a contrasting color with the walkway surface.
3. Devices should not prevent the drainage of water from the walkway. An opening with a 2 inch maximum height above the walkway surface is allowed for drainage.
4. Longitudinal channelizing devices for pedestrians shall have a minimum height of 32 inches. Longitudinal channelizing devices shall not be installed with a handrail.
5. When hand guidance is required, the top surface of the device shall be in a vertical plane perpendicular to the walkway and above the detectable edge with a continuous height of 36-38 inches.
6. All devices should be free of sharp or rough edges with all fasteners installed below the surface and capped to prevent harm to hands, arms or clothing of pedestrians.
7. All devices used to provide guidance for pedestrians shall interlock to prevent gaps between devices.

Temporary Curb Ramps

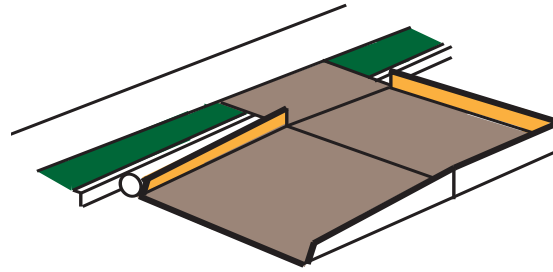

Parallel to Curb

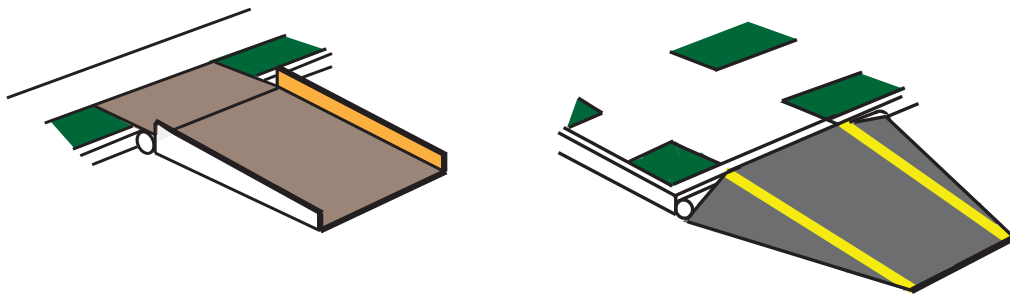

Perpendicular to Curb

1. Curb ramps should be a minimum of 48 inches in width for perpendicular ramps and 60 inches in width for parallel ramps, with a firm, stable non-slip surface.
2. Detectable edges for long canes shall be continuous and a minimum of 6 inches above the walkway surface and be a contrasting color with the ramp and landing surface. For perpendicular ramps, the 6 inch detectable edge may be replaced with a 10:1 apron/flared side and a 2 inch wide marked walkway edge line.
3. Ramps shall have a slope not to exceed a maximum of an 12% (8:1).
4. Curb ramps and turning spaces should have a maximum of 2% (48:1) cross-slope.
5. A level clear space, 48 X 48 inch for perpendicular ramps and 60 X 60 inch for parallel ramps, should be provided above and below the ramp.
6. Curb ramps should be placed to have minimal restriction to water flow in the curb/gutter drainage system.
7. All joints and gaps between surfaces should be less than 0.5 inches.
8. Vertical changes between surface heights should not exceed 0.5 inches. Vertical edges can be vertical up to 0.25 inches. Vertical edges between 0.25 and 0.5 inches shall be beveled at 2:1.

Selecting Appropriate Temporary Pedestrian Access for Work Zones

General Notes for the Temporary Pedestrian Access Route

The pedestrian access route examples illustrated in this guidance are recommended practices and not standards. **The examples should be applied only if an acceptable alternate route does not exist.** In addition, any lane closures must follow the department's lane closure guidance.

Definition and clarification of terms for Temporary Pedestrian Access Routes

The following terms are to be used in conjunction with the three ADA/Pedestrian application charts illustrated on the following pages.

- **Pedestrian Route:** Any level (10:1 or flatter), firm, stable, and slip-resistant surface composed of soil, grass, pavers, asphalt or concrete that is a minimum of 4 feet in width within the right of way for use by pedestrians.
- **Street/Roadway Operations:** Pavement resurfacing such as Mill & Fill/Mill & Overlay work that closes or impedes pedestrian access at curb ramps after milling but prior to resurfacing for a period of more than 1 day (see application chart, Page 8).
- **Maintenance and Utility Operations:** Daytime or nighttime work that closes or impedes pedestrian access on a pedestrian route daily over a period of 3 or fewer days (see application chart, Page 9).
- **Construction Operations:** Work that closes a pedestrian access route for a period of more than 3 consecutive days (see application chart, Page 10).

If a specific work task takes place at a curb ramp for longer than 1 hour an alternate pedestrian route must be provided.

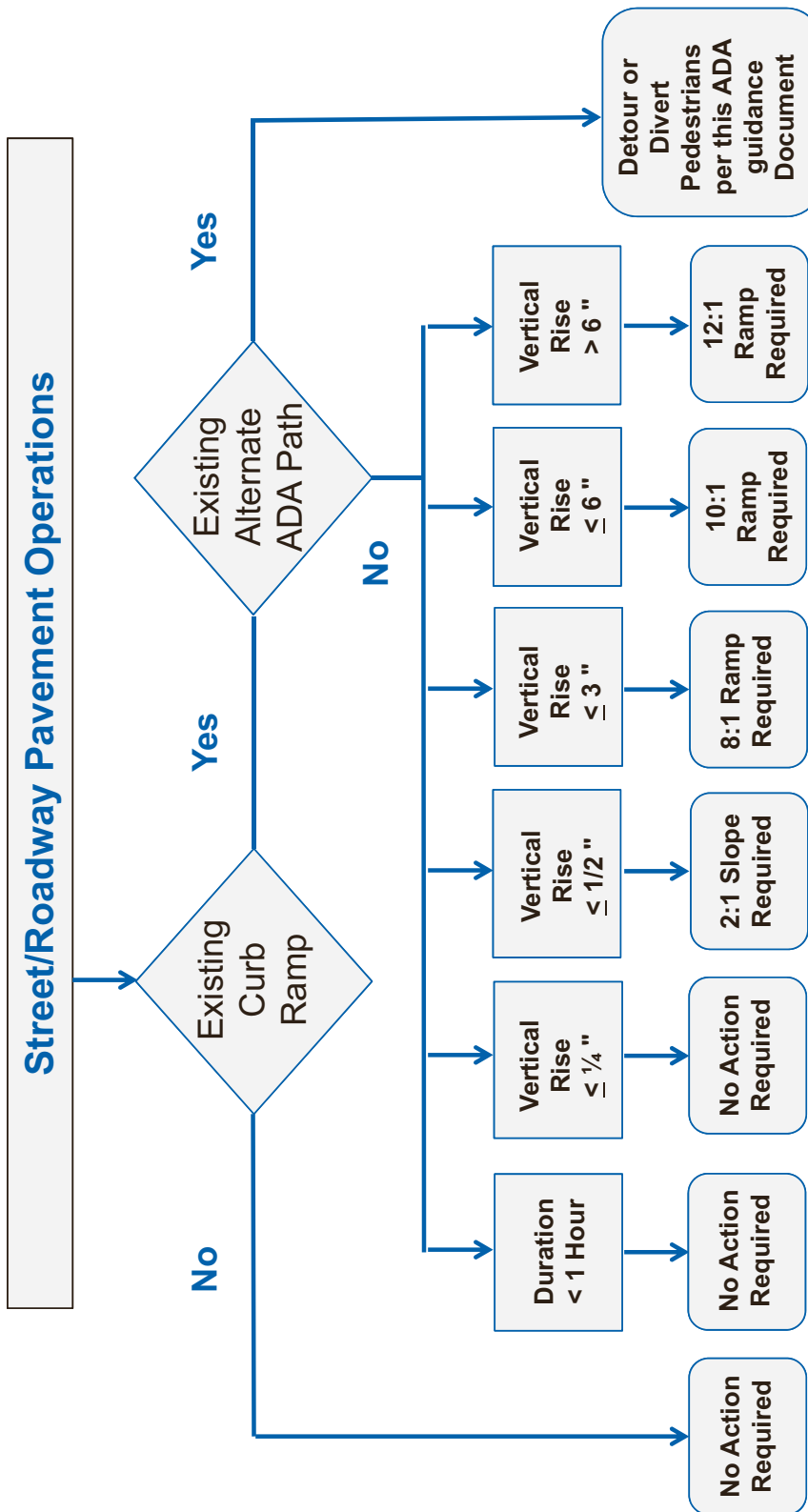

ADA/Pedestrian Application Chart
Street/Roadway Pavement Operation

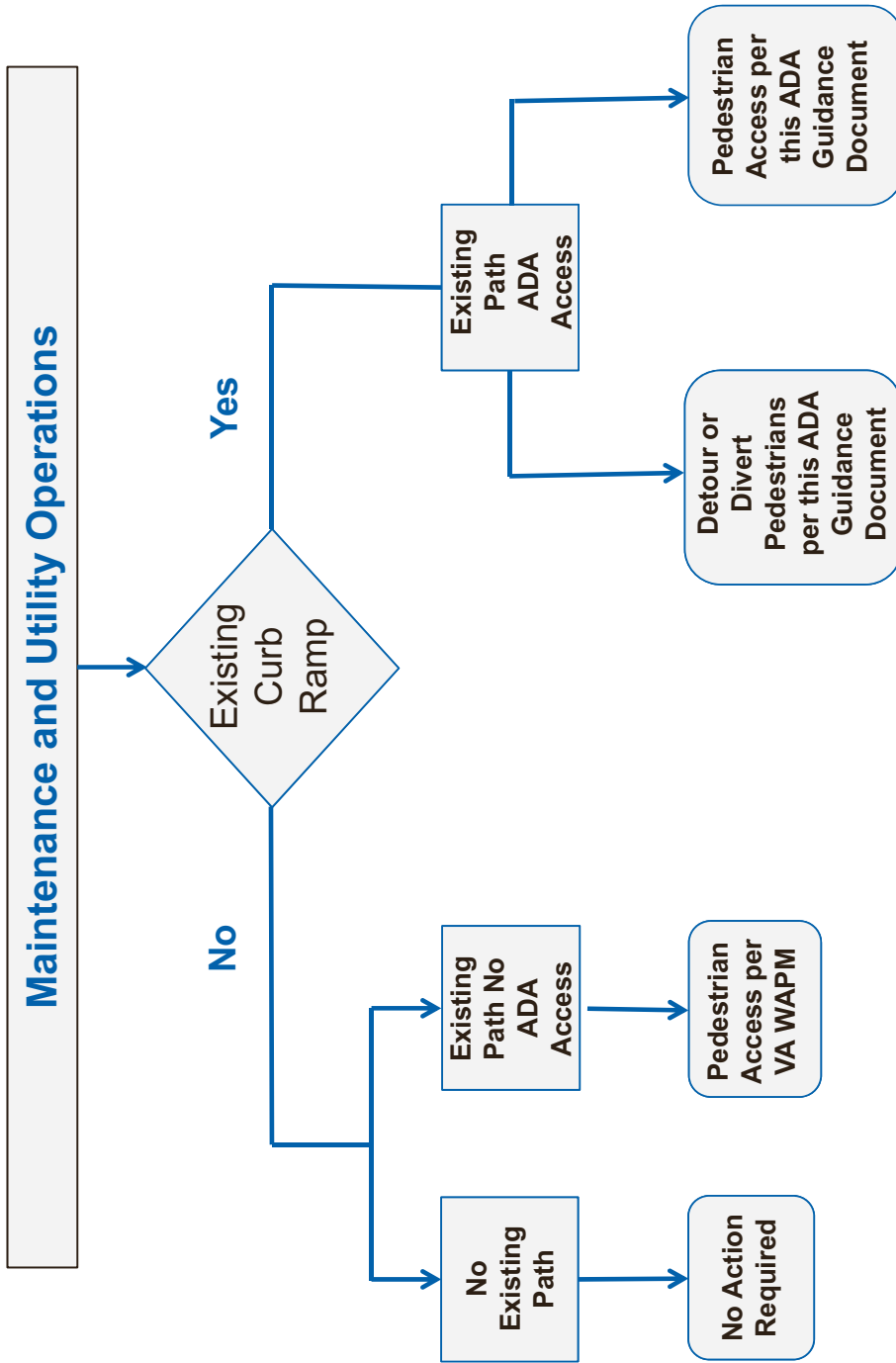

ADA/Pedestrian Application Chart
Maintenance/Utility Operations

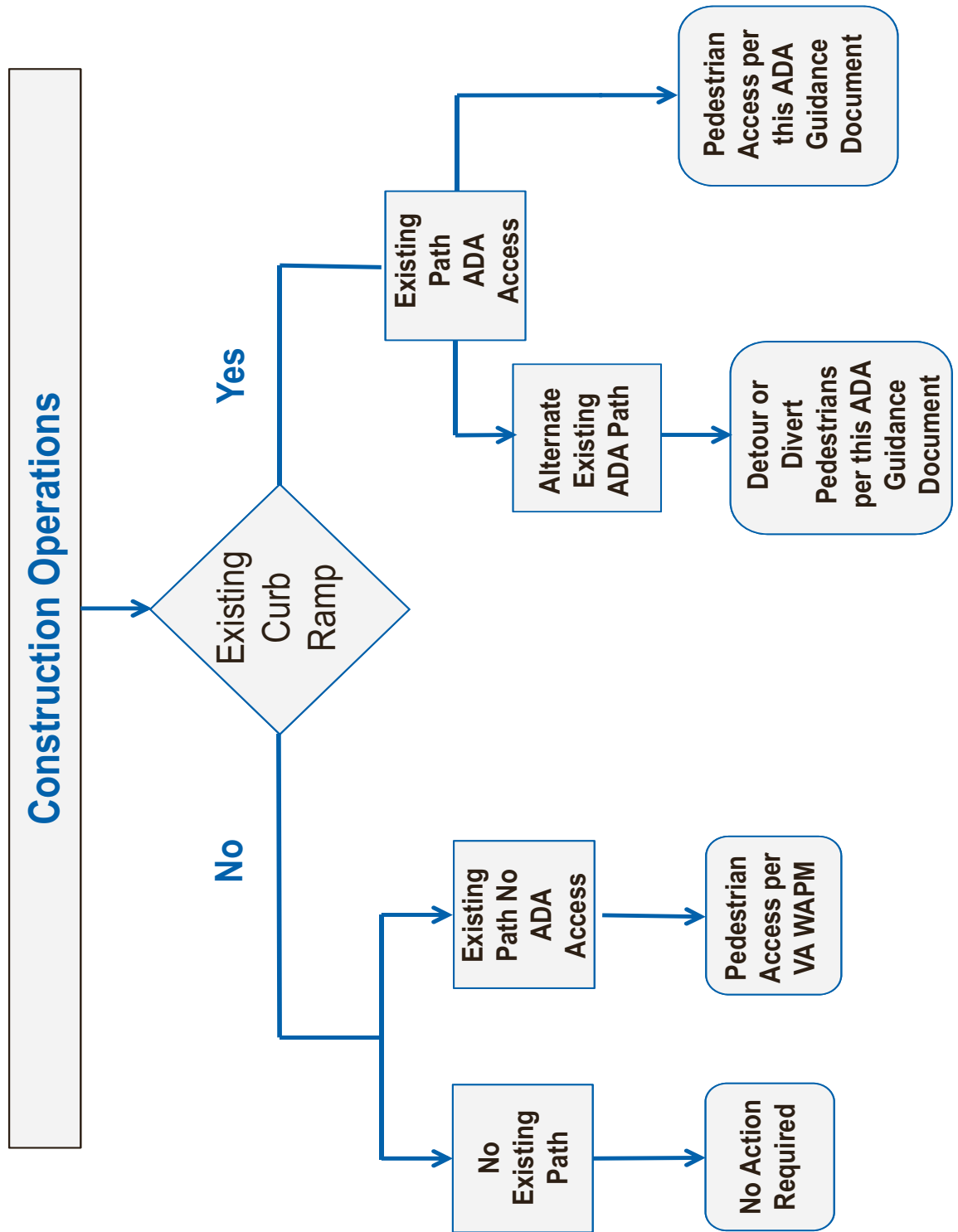

ADA/Pedestrian Application Chart
Construction Operations









Intentional Left Blank

Examples of ADA Compliant Work Zones

The following pedestrian access route examples illustrated are recommended practices. Refer to the current edition of the Virginia Work Area Protection Manual or the Manual on Uniform Traffic Control Devices for specific pedestrian access standards. The examples should be applied only if an acceptable alternate route does not exist.

Pedestrian routes should not be blocked, severed or moved to provide space for parked vehicles, construction equipment or construction materials for up to 1 hour. Space for parked vehicles, construction equipment or construction materials should be provided within the work activity area for time periods greater than 1 hour. If vehicles, equipment or materials remain in the pedestrian route for a period longer than 1 hour an alternate pedestrian should be provided.

The legend below should be used to identify the symbols used in the following examples.

	TYPE 3 BARRICADE		WORK ACTIVITY AREA
	PEDESTRIAN CHANNELIZING DEVICE		SIGN SUPPORT
	PERPENDICULAR CURB RAMP		PARALLEL CURB RAMP
	CHANNELIZING DEVICE		DETECTABLE WARNING SURFACE

Mid-block Diversion

1. When sidewalks, crosswalks, shared-use paths, trails, or other pedestrian facilities are blocked, closed or relocated, temporary facilities shall meet, and if feasible exceed, accessibility features present in the existing facility.
2. The illustrated example only provides typical guidance. Refer to Figure TTC-35 in the Virginia Work Area Protection Manual for standards, guidance and options for blocking, closing or relocating pedestrian facilities.
3. When existing site conditions make it infeasible to meet the recommended standards these conditions shall be documented and retained in the project's file. Only traffic control devices controlling pedestrian movement are illustrated. Other traffic control devices, based on the work operation per the Virginia Work Area Protection Manual, may be needed to control vehicular and pedestrian traffic on the roadway.
5. When both sides of a temporary pedestrian facility require channelizing devices, the devices should be a similar type (longitudinal channelizing device or pedestrian barricade system), excluding traffic barrier, used to protect pedestrians from vehicular traffic.
6. Refer to Appendix A of the current Virginia Work Area Protection Manual for guidance on the application of barriers /channelizing devices in work zones.
7. A motion activated message device(s) may be provided for sight-impaired pedestrians. When used, the message device(s) should provide a complete physical description of the temporary pedestrian facility including duration, length of and/or distance to the facility, restriction or hazards as well as information present on the required signs. The message device(s) may also describe an alternate route.
8. A facility is non-compliant if it is missing key ADA elements such as curb ramps, truncated dome detectable warning, and detectable edging. Other restrictions may include insufficient width, traffic conflicts, steep grades, non-continuous channelizing devices, tripping hazards, uneven/rough/soft surfaces, etc. An alternate route should be provided and posted when a temporary facility is not ADA compliant and when the existing path to be closed has ADA access.

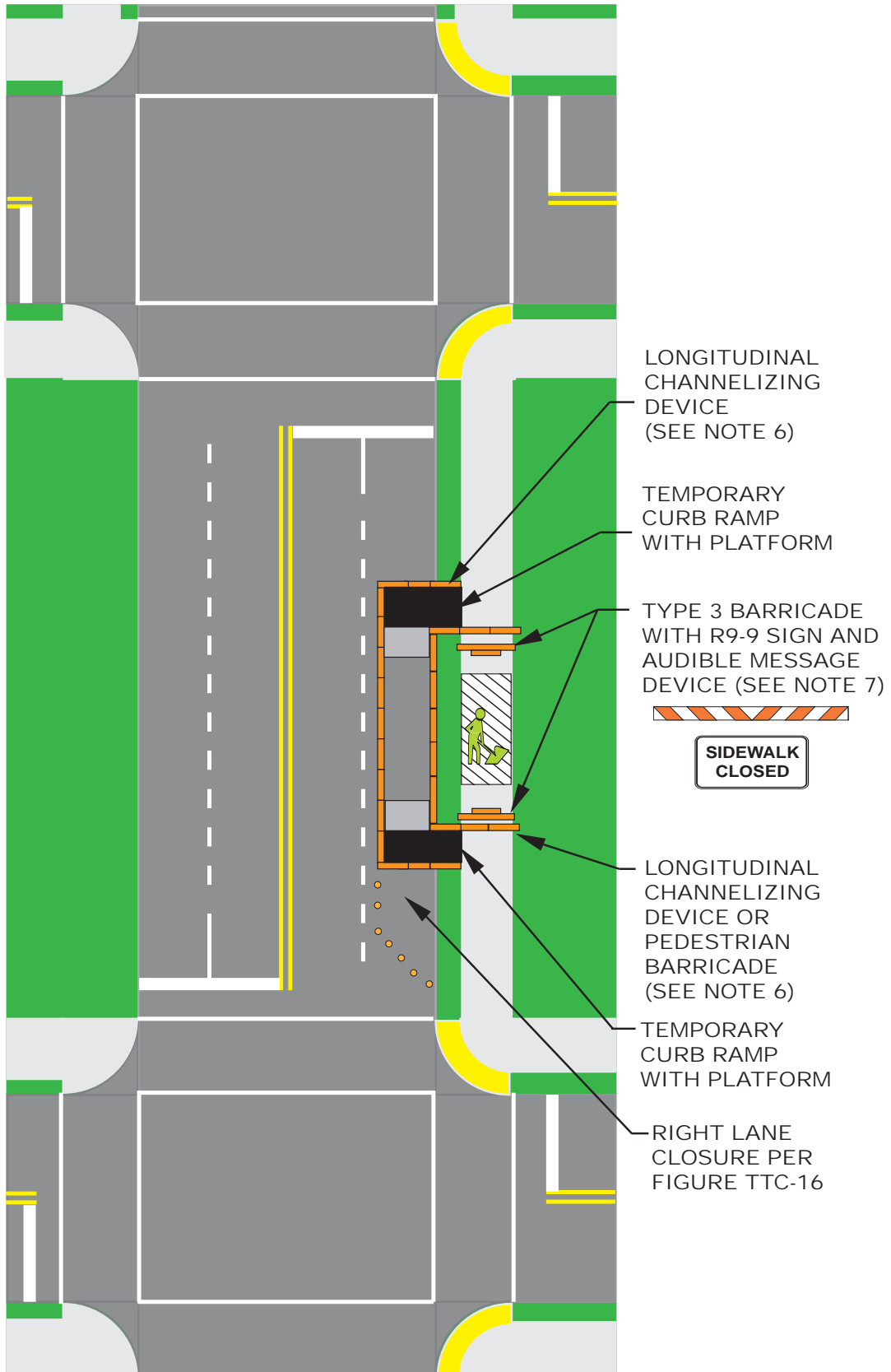

Sidewalk Bypass at an Intersection

1. When sidewalks, crosswalks, shared-use paths, trails, or other pedestrian facilities are blocked, closed or relocated, temporary facilities shall meet, and if feasible exceed, accessibility features present in the existing facility.
2. The illustrated example only provides typical guidance. Refer to the Figure TTC-36 in the current Virginia Work Area Protection Manual for standards, guidance and options for blocking, closing or relocating pedestrian facilities for additional sign and crosswalk pavement marking requirements.
3. When existing site conditions make it infeasible to meet the recommended standards these conditions shall be documented. Conditions may include insufficient width, traffic conflicts, steep grades, non-continuous channelizing devices, tripping hazards, uneven/rough/soft surfaces, etc. An alternate route should be provided and posted when a temporary facility is not ADA compliant.
4. Only traffic control devices controlling pedestrian movement are illustrated. Other traffic control devices, based on the work operation per the Virginia Work Area Protection Manual, may be needed to control vehicular traffic on the roadway.
5. When both sides of a temporary pedestrian facility require channelizing devices, the devices should be a similar type (longitudinal channelizing device or pedestrian barricade system), excluding traffic barrier, used to protect pedestrians from vehicular traffic.
6. Refer to Appendix A of the current Virginia Work Area Protection Manual for guidance on the application of barriers /channelizing devices in work zones.
7. A motion activated message device(s) may be provided for sight-impaired pedestrians. When used, the message device(s) should provide a complete physical description of the temporary pedestrian facility including duration, length of and/or distance to the facility, restriction or hazards as well as information present on the required signs. The message device(s) may also describe an alternate route.
8. When the route between a temporary pedestrian facility and an existing sidewalk is skewed at a crosswalk, a temporary detectable warning strip may be used to provide guidance for sight-impaired pedestrians.
9. VDOT's "[Guidelines for the Installation of Marked Crosswalks](#)" should be used for information on the application of temporary marked crosswalks and the use of appropriate traffic control devices.

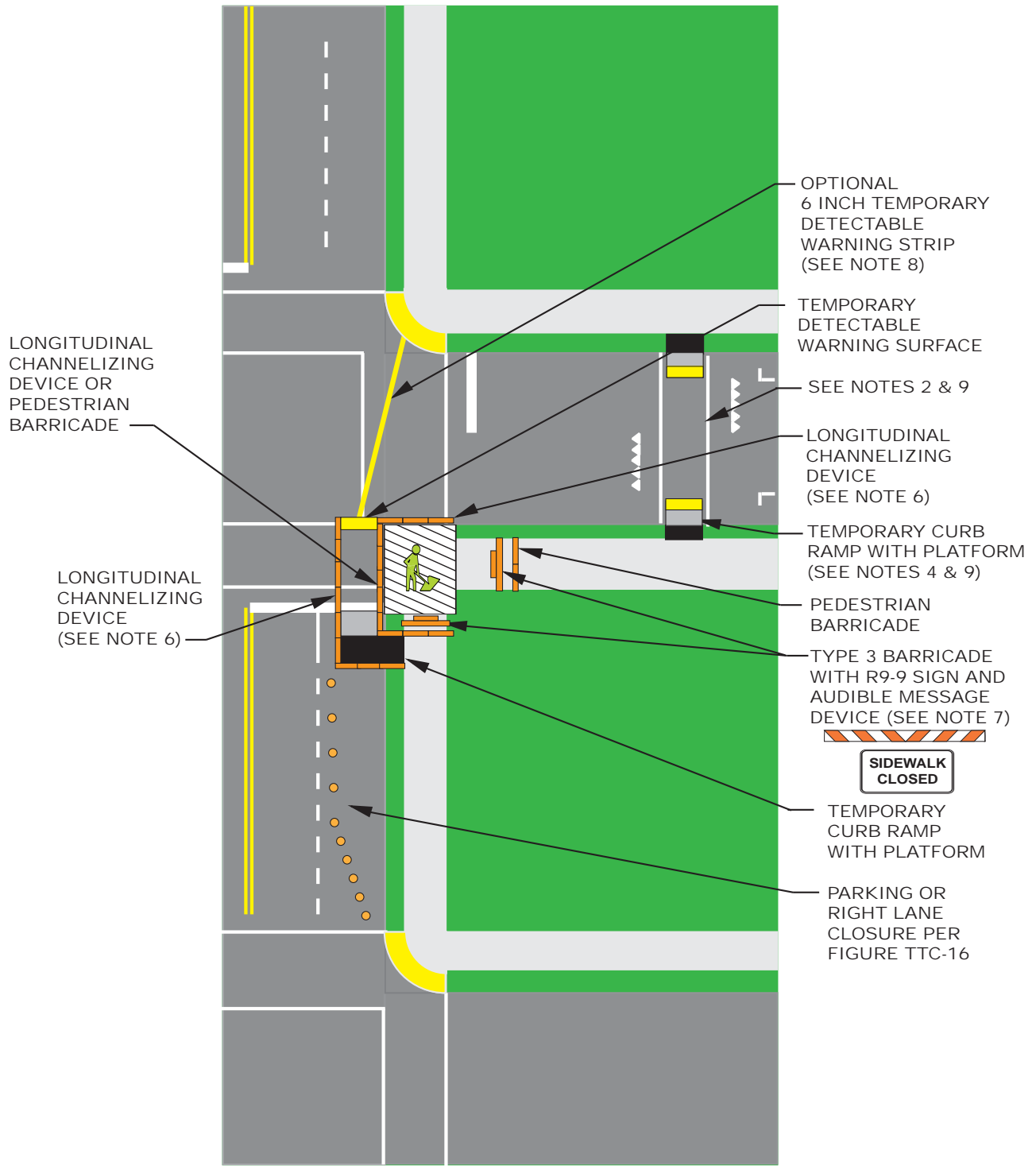

EXAMPLE OF A SIDEWALK BYPASS AT AN INTERSECTION

Sidewalk Mid-block Crossing

1. When sidewalks, crosswalks, shared-use paths, trails, or other pedestrian facilities are blocked, closed or relocated, temporary facilities shall meet, and if feasible exceed, accessibility features present in the existing facility.
2. The illustrated example only provides typical guidance and may be applied to street block lengths of more than 1000 feet. Refer to the current Virginia Work Area Protection Manual for standards, guidance and options for pedestrian facilities.
3. When existing site conditions make it infeasible to meet the recommended standards these conditions shall be documented. Conditions may include insufficient width, traffic conflicts, steep grades, non-continuous channelizing devices, tripping hazards, uneven/rough/soft surfaces, etc. An alternate route should be provided and posted when a temporary facility is not ADA compliant.
4. Only traffic control devices controlling pedestrian movement are illustrated. Other traffic control devices, based on the work operation per the Virginia Work Area Protection Manual, may be needed to control vehicular traffic on the roadway.
5. When both sides of a temporary pedestrian facility require channelizing devices, the devices should be a similar type (longitudinal channelizing device or pedestrian barricade system), excluding traffic barrier used to protect pedestrians from vehicular traffic.
6. Refer to Appendix A of the current Virginia Work Area Protection Manual for guidance on the application of barriers /channelizing devices in work zones.
7. A motion activated message device(s) may be provided for sight-impaired pedestrians. When used, the message device(s) should provide a complete physical description of the temporary pedestrian facility including duration, length of and/or distance to the facility, restriction or hazards as well as information present on the required signs. The message device(s) may also describe an alternate route.
8. When the route between a temporary pedestrian facility and an existing sidewalk is skewed at a crosswalk, a temporary detectable warning strip should be used to provide guidance for sight-impaired pedestrians.
9. VDOT's "[Guidelines for the Installation of Marked Crosswalks](#)" should be used for information on the application of temporary mid-block marked crosswalks and the use of appropriate traffic control devices.
10. W11-2 sign and W16-7 plaque shall be fluorescent yellow-green background.

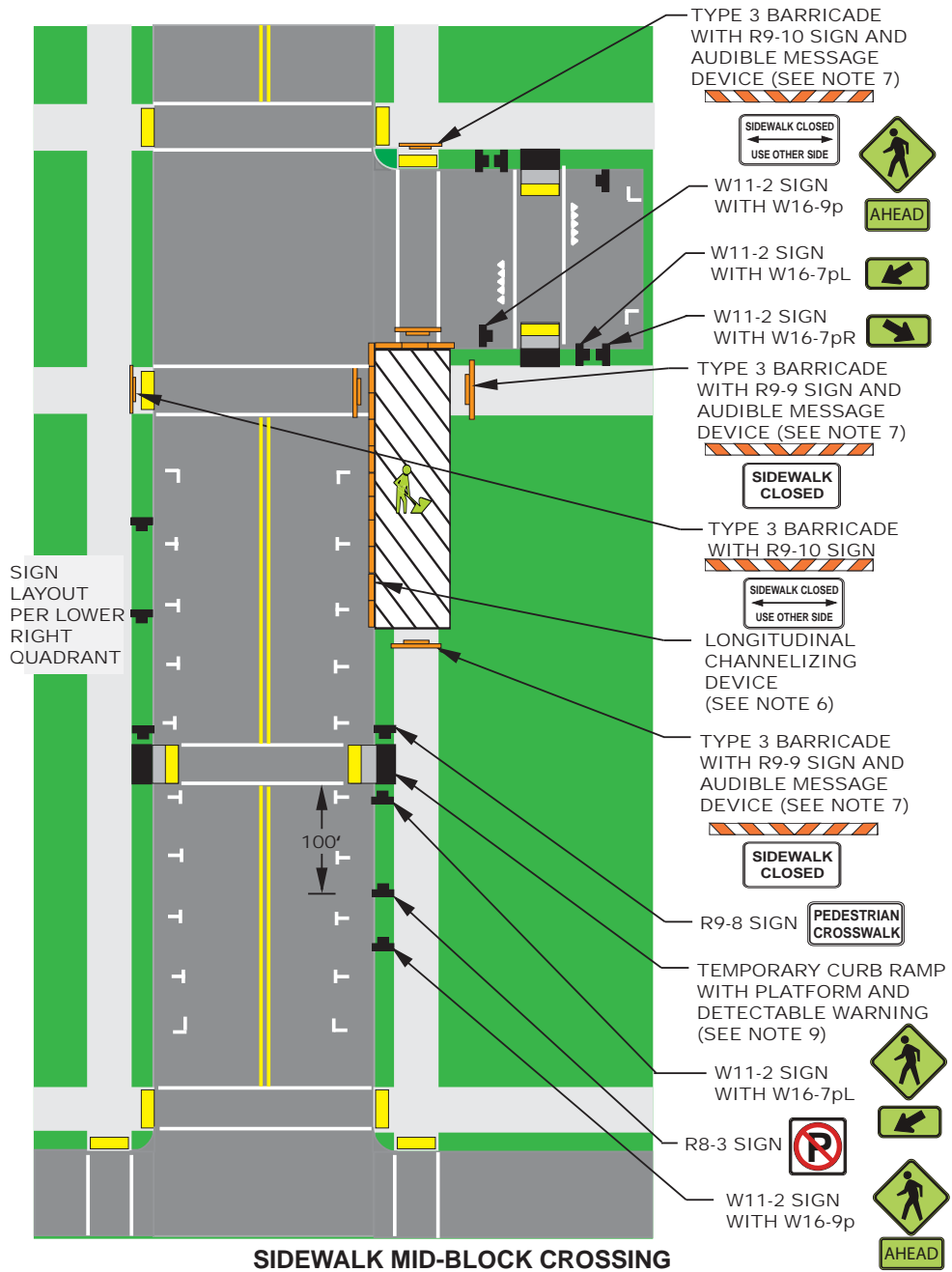

Intentional Left Blank

Bicycle Lane/Shared Lane/Shared-Use Paths

Bicycle Guidance

The construction of bicycle lanes, shared lanes and shared-use paths has increased in recent years due to renewed interest in cycling for travel and commuting. To provide for the safety of the users of these lanes and paths during street repair or construction, the following guidance has been developed to assist in creating Temporary Traffic Control (TTC) Plans for these facilities. The examples in this document will illustrate various examples of applications for accommodating these users under different site conditions.

Guidance through the work area must be provided for other shared-use path users such as pedestrians, in-line skaters, joggers, etc. Refer to the pedestrian guidance section of this document as well as the Virginia Work Area Protection Manual for additional guidance information for these shared-use path users.

The continuity of a designated bikeway should be maintained through the work zone if possible. The continuity of the designated bikeway is especially important where bicyclists have been traveling on a shoulder, bike lane, or shared use path adjacent to a high speed (greater than 35 mph) motorized vehicle travel lane. There is a safety concern if bicyclists were to share the travel lane with motorized vehicles through the work zone on these high speed routes. If available, a reasonable detour route on a lower speed roadway should be provided.

On roadways with 4 or more travel lanes and bicycle lanes or bikeable shoulders, one or more travel lanes could be closed or lanes narrowed to maintain space for the bicycle lane through the work zone. Any lane closures must follow the department's lane closure guidance.

In low-speed (35 mph or less) urban areas where bicycles are sharing the travel lane with motorized vehicle traffic, the work zone for the motorized vehicles should be adequate for bicyclists as well.

On-road bicyclists should not be directed onto a path or sidewalk except where such a path or sidewalk is a shared-use path, or there is no practical alternative during a rehabilitation project.

If a bikeway detour is unavoidable it should be as short and direct as practical.

If a portion of a bikeway is to be closed due to construction activities and the detoured bikeway follows a complex path not in the original bikeway corridor, then a full detour plan should be developed and implemented. The TTC Plan for the detour of the bikeway should include all necessary advanced warning (W21 series) signs and detour (M4-9 series) signs, as well as any other temporary traffic control devices necessary to guide bicyclists along the detour route.

The BICYCLES MAY USE FULL LANE (R4-11) sign should be used when the following conditions exist:

- Roadways and streets with a maximum speed limit of 35 MPH, and
- Where the combined travel lane and usable shoulder width is less than 14 feet.

The BICYCLES MAY USE FULL LANE (R4-11) sign should not be used on undivided unmarked roadways.

The Bicycle Warning (W11-1) symbol sign with the SHARE THE ROAD (W16-1p) supplemental plaque should be used when the following conditions exist:

- Where a bike lane or shared-use path end and users are detoured to the roadway,
- Where the posted speed limit is 40 MPH or greater, and
- Where the combined travel lane and usable shoulder width on the detour route is reduced to less than 14 feet.

Refer to Part 9 of the current edition of the Virginia Supplement to the 2009 MUTCD for additional information on the application of the BICYCLES MAY USE FULL LANE (R4-11) sign and the Bicycle Warning (W11-1) symbol sign with the SHARE THE ROAD (W16-1p) supplemental plaque.

The following examples contain additional information on accommodating bicycles in work zones. Refer to the Work Area Protection Manual for specific information on the application, placement and spacing of temporary traffic control devices.

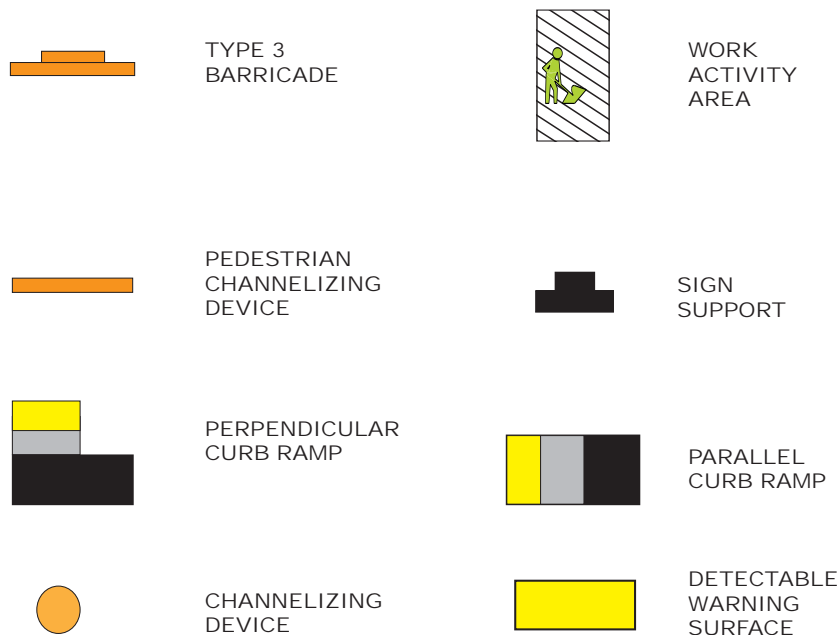

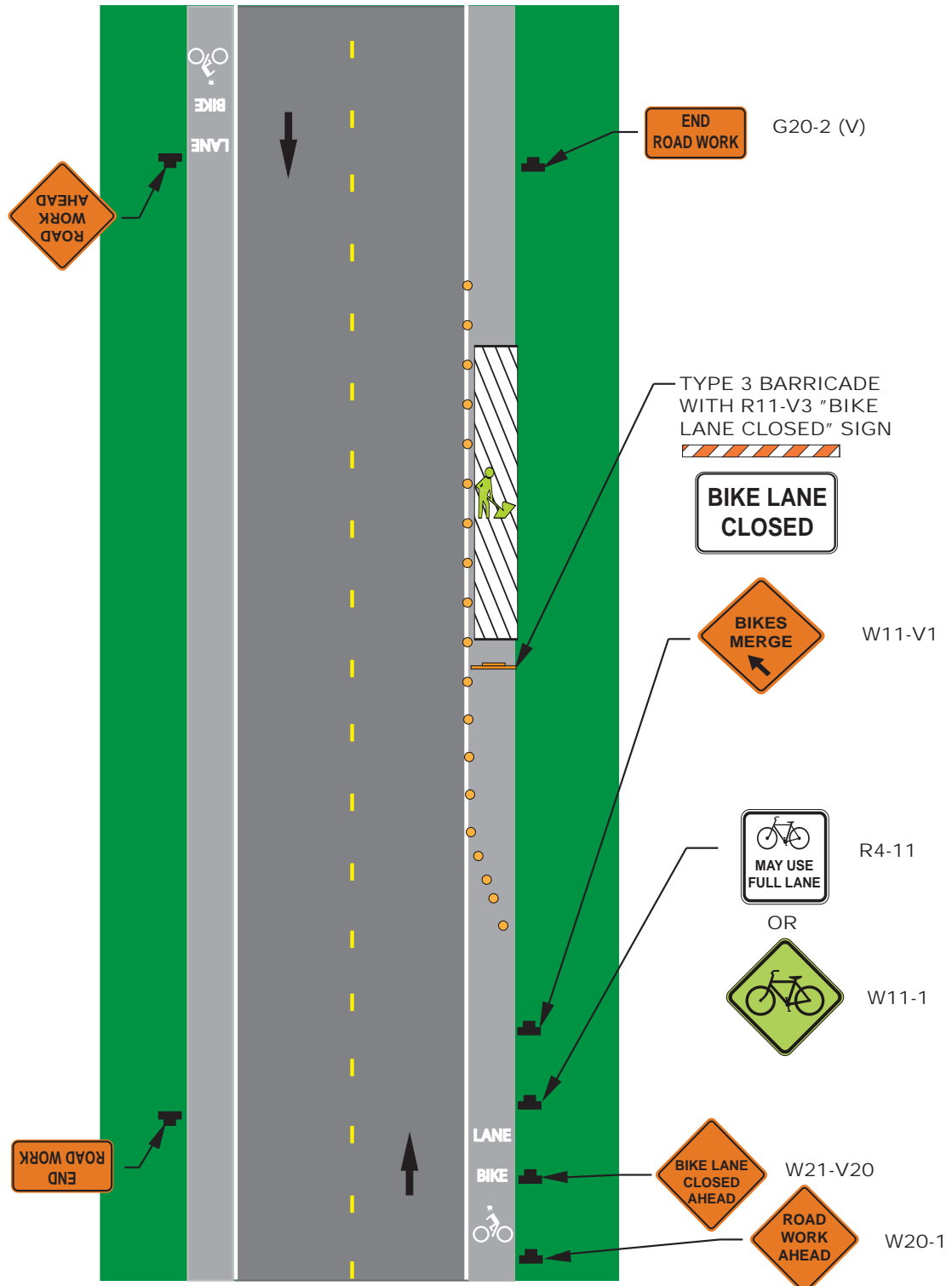

EXAMPLE OF A BICYCLE LANE CLOSURE

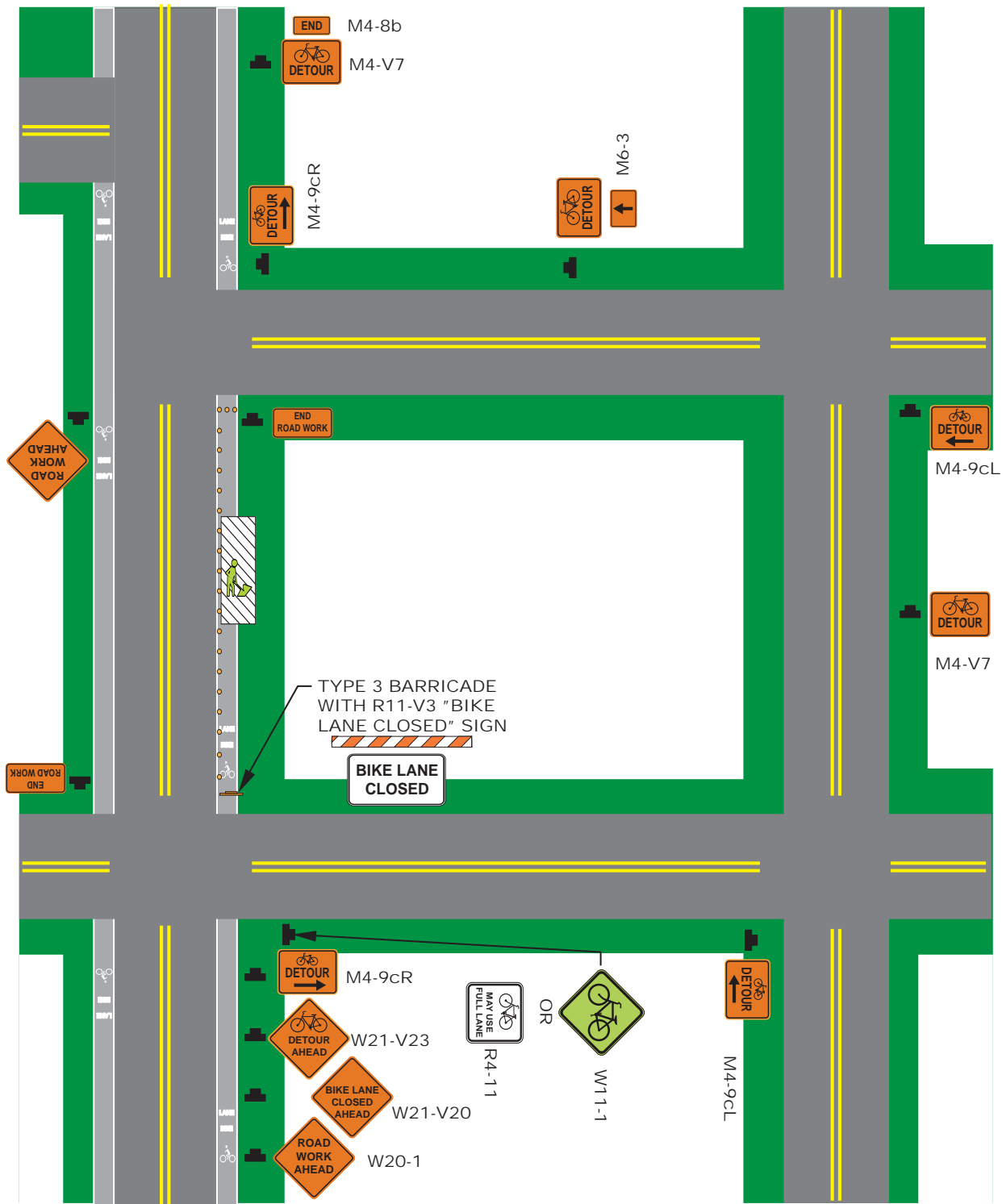

EXAMPLE OF A BICYCLE LANE CLOSURE WITH DETOUR

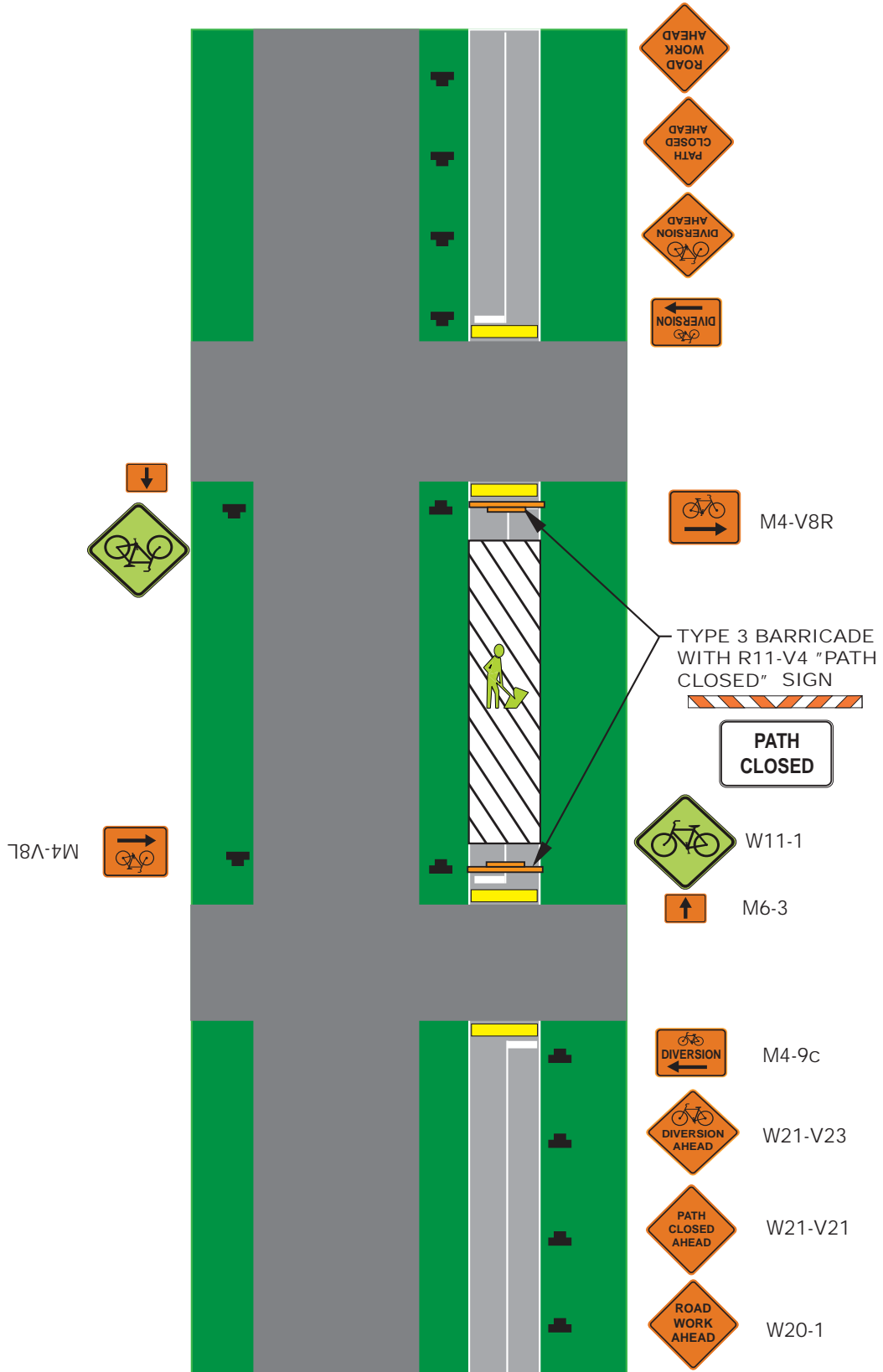

EXAMPLE OF A SHARED-USE OR BICYCLE PATH CLOSURE WITH DIVERSION

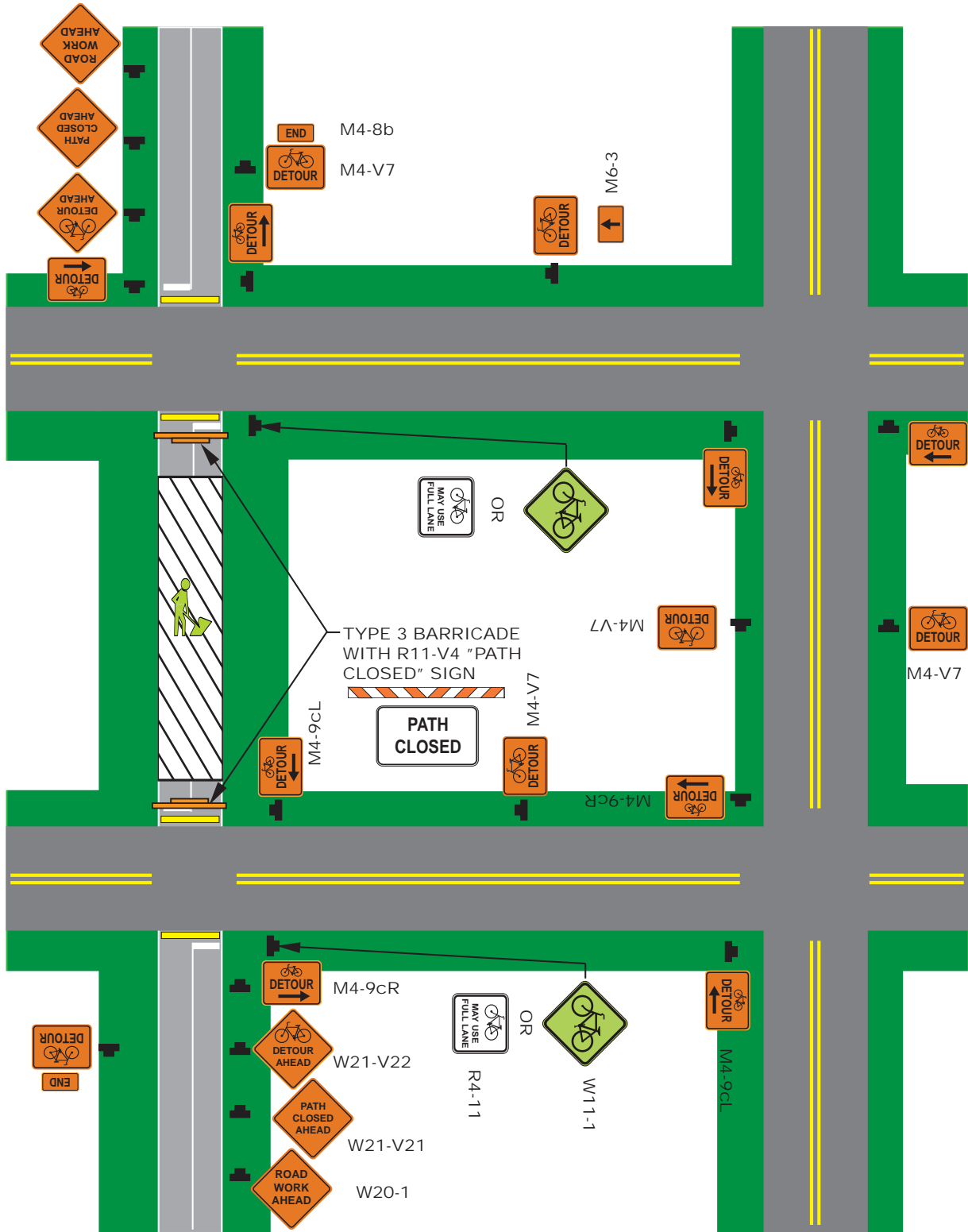

EXAMPLE OF A SHARED-USE OR BICYCLE PATH CLOSURE WITH DETOUR

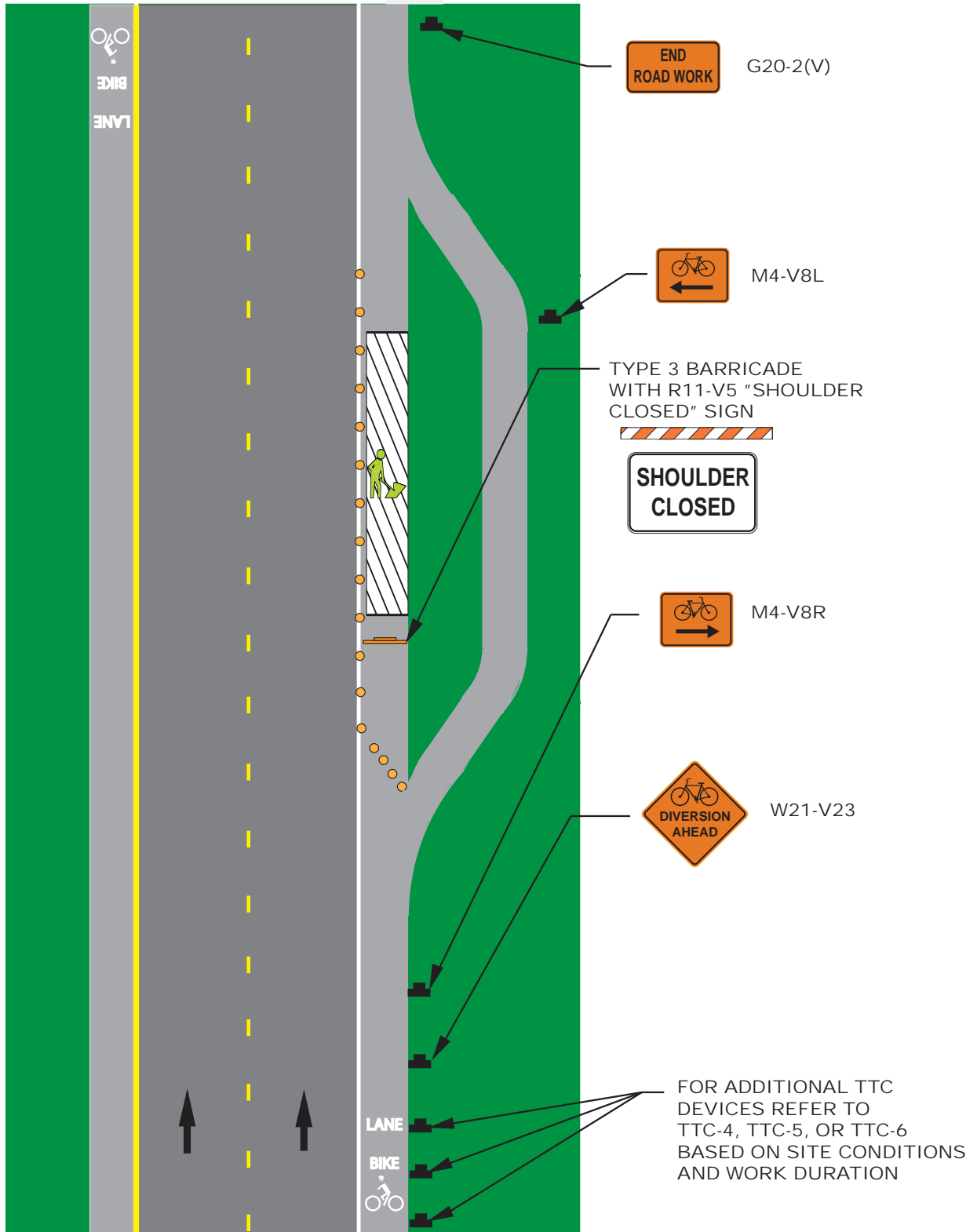

EXAMPLE OF A SHOULDER CLOSURE WITH A BICYCLE DIVERSION PATH

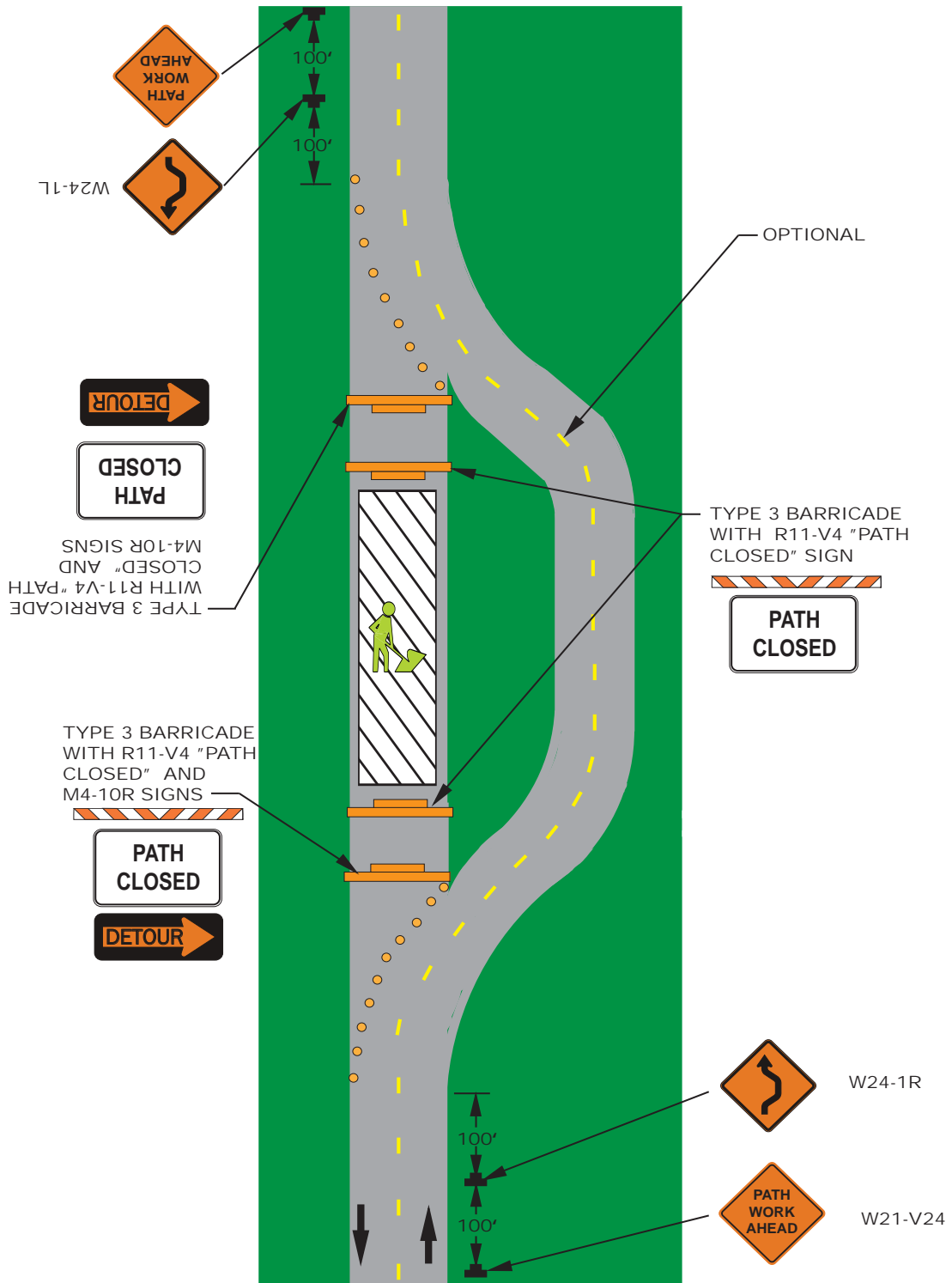

EXAMPLE OF A PATH CLOSURE WITH A DIVERSION PATH

ADA/Pedestrian/Bicycle Accessibility Checklist

ADA/Pedestrian Checklist

This project has been reviewed for the various temporary traffic control provisions for pedestrian accessibility considerations contained in the current MUTCD, the Virginia Work Area Protection Manual, and the guidance published in the Virginia Work Zone Pedestrian and Bicycle Guidance document. Considerations as listed below have been reviewed and where applicable, deviations and/or exceptions from the MUTCD, the Virginia Work Area Protection Manual, and the Virginia Work Zone Pedestrian and Bicycle Guidance document are documented.

IS IT REASONABLE TO EXPECT THAT PEDESTRIANS
WILL BE PRESENT WITHIN THE VICINITY OF THE
PROPOSED TEMPORARY TRAFFIC CONTROL ZONE?

YES - complete the following checklist

NO - document your conclusion

When existing pedestrian facilities (routes) are disrupted, closed, or relocated in a temporary traffic control zone, the temporary facilities shall be detectable and include accessibility features consistent with the features present in the existing pedestrian facility.

A. Will a reasonably safe, convenient, and accessible route be provided that replicates as much as practical the characteristics of the existing pedestrian facility?

YES NO (partially) document your decision

B. Will access be provided to current or temporary transit stops?

YES NO (partially) document your decision

C. Will all pedestrian facilities near the work zones be separated from the work area by appropriate barriers that maintain the accessibility and detectability for pedestrians with disabilities?

YES NO (partially) document your decision

D. Will a smooth, continuous hard surface that will not cause tripping or restrict wheelchair use be provided throughout the entire length of the temporary pedestrian facility?

YES NO (partially) document your decision

E. Will blocked routes, alternate crossings, sign and signal information be communicated to pedestrians with visual disabilities? Devices may include audible information devices and accessible pedestrian signals. Other ADA compliant pedestrian devices may include barriers/channelizing devices that are detectable to the pedestrians traveling with the aid of a long cane or who have low vision. Where pedestrian traffic is detoured to a signal, engineering judgment should be used to determine if pedestrian signals or accessible pedestrian signals should be considered for crossings along an alternate route.

YES NO (partially) document your decision

F. Will sidewalk(s) be closed properly with advance notification to the public? Advance notification of sidewalk closures shall be provided to the public. When a sidewalk is closed, a barrier that is detectable by a person with a visual disability traveling with the aid of a long cane shall be placed across the full width of the closed sidewalk.

YES NO (partially) document your decision

G. Will channelization with continuous edging be used to delineate a pedestrian pathway throughout the length of the facility such that pedestrians using a long cane can follow it? (These detectable edgings should adhere to the provisions of Section 6F.68 of the Virginia Work Area Protection Manual.)

YES NO (partially) document your decision

H. Will the width of the existing pedestrian facility be provided for the temporary facility? Where it is not possible to maintain a width of 60 inches throughout the entire length of the pedestrian route, is a 48 inch wide path with a 60 x 60 inch passing space provided at least every 200 feet to allow individuals in wheelchairs to pass?

YES NO (partially) document your decision

I. Is the accessible route free of intrusions by traffic control devices and construction materials? Signs and other devices mounted lower than 7 feet above the temporary pedestrian pathway should not project more than 4 inches into accessible pedestrian facilities. Barricade rail supports should not project into pedestrian circulation routes more than 4 inches from the support between 27 inches and 80 inches from the surface. Ballast shall not extend into the accessible passage width of 60 inches. Refer to Section 6F.76 of the Virginia Work Area Protection Manual for more details.

YES NO (partially) document your decision

ADA/Pedestrian/Bicycle Accessibility Checklist

Bicycle/Shared-Use Path Checklist

This project has been reviewed for the various temporary traffic control provisions for bicycle considerations as well as other self-propelled devices contained in the current MUTCD, the Virginia Work Area Protection Manual, Virginia Work Area Protection Manual and the guidance published in the Virginia Work Zone Pedestrian and Bicycle Guidance document. Considerations as listed below have been reviewed and where applicable, deviations and/or exceptions from the MUTCD, the Virginia Work Area Protection Manual, and the Virginia Work Zone Pedestrian and Bicycle Guidance document are documented.

IS IT REASONABLE TO EXPECT THAT MIXED TRAFFIC (BICYCLISTS/ MOTORIZED VEHICLES) WILL BE PRESENT WITHIN THE VICINITY OF THE PROPOSED TEMPORARY TRAFFIC CONTROL ZONE?

YES - complete the following checklist

NO - document your conclusion

When existing bicycle facilities (routes) are disrupted, closed, or relocated in a temporary traffic control zone, the temporary facilities shall include features consistent with the features present in the existing bicycle facility.

A. Will a reasonably safe, convenient, and accessible path be provided that replicates as much as practical the characteristics of the existing bicycle facility?

YES NO (partially) document your decision

B. Will bicycle facilities near the work zones be separated from the work area by appropriate barriers?

YES NO (partially) document your decision

C. Will blocked routes, alternate crossings, sign and signal information be communicated to bicyclists?

YES NO (partially) document your decision

D. Will a bike lane or shared use path be closed properly with advance notification to the public?

YES NO (partially) document your decision

E. Is the detour route used to guide bicyclists throughout the length of the detour properly signed such that bicyclists can follow the alternate route?

YES NO (partially) document your decision

F. Does the temporary bicycle facility provide the same level of continuity as the existing bicycle facility?

YES NO (partially) document your decision

Resources

- United States Access Board's Proposed Right-of-Way Accessibility Guidelines:
<http://www.access-board.gov/guidelines-and-standards/streets-sidewalks/public-rights-of-way/proposed-rights-of-way-guidelines>
- United States Access Board's Public Right of Way Access Advisory Committee's Special Report on Accessible Public Rights-of-Way Planning and Designing for Alterations:
<http://www.access-board.gov/guidelines-and-standards/streets-sidewalks/public-rights-of-way/guidance-and-research/accessible-public-rights-of-way-planning-and-design-for-alterations>
- Applying the Americans with Disabilities Act in Work Zones: A Practitioner Guide:
<https://www.workzonesafety.org/research/record/25221>
- Pedestrian Safety and Accessibility in Work Zones:
http://www.workzonesafety.org/files/documents/training/fhwa_wz_grant/atssa_pedestrian_work_zones.pdf
- Guidance Sheet-Temporary Traffic Control Zone Pedestrian Access Considerations:
<https://www.workzonesafety.org/node/10588>
- FHWA's A Resident's Guide for Creating Safe and Walkable Communities:
http://safety.fhwa.dot.gov/ped_bike/ped_cmnty/
- Manual on Uniform Traffic Control Devices (MUTCD):
http://mutcd.fhwa.dot.gov/kno_2009.htm
- 2011 Virginia Supplement to the MUTCD:
http://www.virginiadot.org/business/virginia_mutcd_supplement.asp
- 2011 Virginia Work Area Protection Manual:
http://www.virginiadot.org/business/resources/Wrk_zone/2011_WAPM_Rev_1.pdf

